

PRODUCT TECHNICAL AND OPERATIONAL DOCUMENTATION

INSTALLATION AND OPERATING MANUAL AND INSTRUCTIONS FOR SAFE USE

- 2. Sun protection screen Refleksol
- 2.11 Refleksol 103

PRODUCT NAME:

- SUN PROTECTION SCREEN
REFLEKSOL 103

PRODUCT MANUFACTURER'S MARKING:

- Manufacturer's name:
SELT Sp. z o. o.
- Manufacturer's head office:
45- 449 Opole, ul. Wschodnia 23A
- Plant address:
Wydział Żaluzji Fasadowych i Refleksoli [Façade and External Textile Roller Blind Department]
45- 449 Opole, ul. Wschodnia 23A
- Contact details:
Tel: +48 77 553 21 00 (sekretariat)
Fax: +48 77 553 22 00
- Website
www.selt.com
- E-mail:
selt@selt.com

PRODUCT SAFETY MARKING:

Product conforms to CE safety requirements.

This Technical and Operational Documentation:

- Is valid from: 01 April 2017
- Is valid for product versions designated above

TABLE OF CONTENTS

1.	Introduction	4
1.1.	Product safety tips.....	4
1.2.	Notes on symbols and marks.....	4
1.3.	Definitions	5
1.4.	Subject, designation and contents of the documentation	5
2.	Product technical information	7
2.1.	Technical parameters:	7
2.2.	Product characteristics	7
3.	Product transport and storage.....	8
3.1.	Completeness and qualitative state of delivery	8
3.2.	General conditions of product transport and storage	8
3.3.	Descriptions that have to be put obligatory on the product packaging.....	9
4.	Product installation.....	9
4.1.	Requirements for safe installation at heights	9
4.2.	Preparation to installation.....	10
4.3.	General guidelines for installation.....	10
4.4.	Installation tools	10
4.5.	Installation	10
4.5.1.	Guide rails installation.....	11
4.5.2.	Cassette installation	13
4.5.3.	Antiwind bar installation	14
4.5.4.	Cable guides installation	15
4.6.	Electric drive	18
4.6.1.	Connection to power supply	18
4.6.2.	Start-up and adjustment	19
4.6.3.	Manual drive	19
5.	System operation and product safety.....	20
5.1.	General safety requirements.....	20
5.2.	Safety requirements connected with particular conditions and places of product use.....	20
5.3.	Operation safety	20
5.4.	Supervision of safe product use	22
6.	System use and maintenance	22
6.1.	Using the product in accordance with its intended use	22
6.2.	Instructions for non-professionals.....	22
6.3.	Technical inspections, maintenance and repairs.....	23
7.	General warranty conditions	24
7.1.	Exclusions for warranty	24
8.	Complaints/ technical faults	25
8.1.	Complaints.....	25
8.2.	Technical faults.....	25
9.	Product disassembly / utilisation / disposal	26
10.	Marking and labelling the product with the CE mark	27
10.1.	Product compliance with the CE standard	27
10.2.	Information accompanying the CE marking	27

1. INTRODUCTION

1.1. PRODUCT SAFETY TIPS

The product was manufactured in accordance with the latest know-how in the area of constructing and manufacturing and is delivered in condition allowing for its safe use.

Safe construction of the external product is achieved by:

No.	Subject	European legal basis	Polish legal basis
1	External blinds. Performance requirements including safety	EN 13561:2015	PN-EN 13561:2015
2	Construction products (CPR)	Regulation 305/2011 of the European Parliament and the Council	DZ. U [Journal of Laws] 2004, No. 92, item 881 as amended by, DZ. U [Journal of Laws] 2016, No. 1570; 2015, No. 1165; 2016, No. 542
3	Essential requirements for machines	Directive 2006/42/EC of the European Parliament and the Council	Resolution of the Minister of Economy of 21 October 2008 DZ.U. [Journal of Laws] 2008 no. 199, item 1228 as amended DZ.U. [Journal of Laws] 2011.124

Linked documents: Declaration of performance, Declaration of conformity (product with motor) and manual of installation and use of motors and control.

Safe construction of internal product is achieved by:







No.	Subject	European legal basis	Polish legal basis
1	Internal blinds. Performance requirements including safety	EN 13120:2009+A1:2014	PN-EN 13120+A1:2014-04
2	Essential requirements for machines	Directive 2006/42/EC of the European Parliament and the Council	Resolution of the Minister of Economy of 21 October 2008 DZ.U. [Journal of Laws] 2008 no. 199, item 1228 as amended DZ.U. [Journal of Laws] 2011.124
3	General product safety	Directive 2001/95/EC of the European Parliament and the Council	DZ.U. [Journal of Laws] of 12 December 2003, no. 229, item 2275 as amended.

Linked documents: Declaration of conformity (product with motor) and manual of installation and use of motors and control.

1.2. NOTES ON SYMBOLS AND MARKS

The below symbols (icons) denote particularly important information concerning threats and safety.

Icon	Icon meaning	Information
	INFORMATION	<p>Prior to using the product, its operating manual should be read.</p> <p>Following the operating manual guarantees:</p> <ul style="list-style-type: none"> - failure-free use of the product, - warranty coverage against product defects. <p>Keep the operating manual for safety of people.</p>

	INFORMATION	No harmful or dangerous consequences for people or facilities.
	ATTENTION!	A situation likely to cause product damage or other damage. No threat for people.
	WARNING!	Threat of danger
	DANGER!	This symbol denotes all information concerning danger, failure to observe which brings about threat to human life and health. Risk: threat of serious injury or death. Dangerous operation which may cause injuries or product damage.
	WARNING!	Threat to human life or health due to electric shock.
	ENVIRONMENT	Marking on electric or electronic equipment subject to collection in designated places.

1.3. DEFINITIONS

The terms and definitions used within this documentation shall mean:

ROLLER BLIND/PRODUCT: internal or external blind, installed in front of a window or in a window or in any place within the internal or external surface of a building, where stretching and pulling (lifting and lowering) of the fabric is performed with the use of a control mechanism (an electric mechanism with a drive system connected to the control system).

FABRIC: part of the product made from fabric or other material; it is put into motion with the use of a control mechanism assuring the product fulfills its function.

1.4. SUBJECT, DESIGNATION AND CONTENTS OF THE DOCUMENTATION

Products manufactured by **SELT Sp. z o. o.** are the subject of this documentation.



Operating manual and instructions for safe use along with the manual for the engine, switches and control shall be submitted to the end user.

IMPORTANT INFORMATION REGARDING SAFETY
WARNING – FOLLOWING THE MANUAL IS ESSENTIAL FOR SAFETY OF PEOPLE
KEEP THIS MANUAL



The documentation is valid jointly with the information concerning a specific product, which is available on the website www.selt.com

The documentation includes:

- important recommendations concerning product installation, use and maintenance,
- important recommendations concerning product transport and storage,
- tips following which will assure long-time and fault-free use of the product.

SELT Sp. z o. o. shall not bear responsibility for damage resulting from failure to follow recommendations included in the documentation.

In order to further improve the product, SELT Sp. z o. o. reserves the right to introduce changes which, while maintaining the essential technical parameters, shall be deemed purposeful for improving product operation quality and safety of use.

SELT Sp. z o. o. with a head office in Opole shall hold the copyrights to this documentation. The documentation cannot be used without permission, either partially or as a whole, for any concurrent business activity nor can it be made available to third parties.

2. PRODUCT TECHNICAL INFORMATION

Product technical specification is available at www.selt.com after log in.

2.1. TECHNICAL PARAMETERS:

Refleksol 103		
Dimensions:	width	height
Cassette	107 mm	117 mm
Refleksol 103 (Aluminium side guides)	4500 mm	4000 mm
Refleksol 103 (cable guides – external use)	3500 mm	3000 mm
Refleksol 103 (cable guides – internal use)	4500 mm	4000 mm
Refleksol 103 (with Anti-wind bar)	3000 mm	4000 mm
Refleksol 103 Available with cable guides, aluminium guides or free-hanging (internal only)		
Manual drive		
Crank	From anodised aluminium, standard height 180 cm	
Electric drive parameters:		
- supply voltage	230V/50Hz	
- power	120 to 200 W	
- current consumption	0,5 to 0,8 A	
- protection level	IP 44	
- continuous work time	4 mins	
- cooling time	16 mins	
- torque	6 – 15 Nm (depending on motor type)	
- the rate of rotation	14, 16, 17, 26, 55 rpm (depending on motor type)	
- work temperature	-20 °C to +70 °C (depending on motor type)	
Installation:		
Intended use	External and internal	
Installation place	To the ceiling or wall	

Detailed data concerning individual motor parameters is available from manufacturer's websites as well as on: www.selt.com → PRODUCTS → AUTOMATION

2.2. PRODUCT CHARACTERISTICS

Refleksol 103 is a system, which according to the configuration chosen can be equipped with ANTIWIND bars, aesthetic cable guides, or serve as a total black-out system (only for internal use). GC30F and GC30FD guide rails may serve as cassette's bearing element.

Refleksol 103 types:

- Installed on the outside of the building, operated with electromechanic drive connected to the control system.
- Installed on the outside of the building, operated manually with crank.
- Installed inside, operated with electromechanic drive connected to the control system.
- Installed inside, operated manually with crank.

The products are characterised by the following qualities:

- they are designed for installation in the window area,
- they limit the sun light coming into the room,
- they provide disperse light in the room
- they prevent rooms from overheating, thus contributing to the improvement of thermal comfort in rooms,
- they help to limit the costs of air conditioning in the rooms,
- they limit the noise transmission to the inside
- they do not emit any toxic substances during their work,
- emission of noise through a product with electronic drive (connected with work of mechanical parts caused by electric drive during its work) is not said to be a significant danger and it is a way of comfort, the level of acoustic pressure is up to 58dB,
- the motors have the security level IP44 which means that they are prevented from touching elements movable and under voltage with tools and wires of >1mm diameter and that they are protected from splashes of water from any direction,
- the construction of the product and driver allows to stop the fabric safely at any height within the up-down work area and stay there suspended,
- up and down movement is performed with the use of crank or an electric switch or with a remote controller,
- casings for the movable parts were designed and performed in a manner assuring safety for operators as long as they are used properly.



In Refleksol products with big dimensions, when there is the need to connect the fabric stripes by welding (horizontal fabric connections), there might appear the "memory effect" of the fabric. The rolling of the fabric does not cause improper functioning of the system and is not a defect of the product.

3. PRODUCT TRANSPORT AND STORAGE

3.1. COMPLETENESS AND QUALITATIVE STATE OF DELIVERY

Selt Sp. z o. o. makes every effort to ensure that the goods are produced in accordance with the order. To check the completeness of the product is purchaser's duty and it should be conducted at the time of delivery. Any discrepancies of the product with the order should be reported immediately to the driver/warehouseman/installers and noted in the proof of delivery at the risk of losing warranty. Checking the quality of the apparent defects should be done by the purchaser at the time of delivery. As apparent defects are considered mechanical damages, scratches, cracks, etc. Any discrepancies in quantity or possible replacements of parts being the evident result of Selt Sp. z o. o. fault, the company agrees to supplement or replace in the shortest possible time.

3.2. GENERAL CONDITIONS OF PRODUCT TRANSPORT AND STORAGE

List:

- The product is factory-packed in a cardboard box to prevent its damage during storage, transport and during its transportation to the place of final assembly,
- For the transport purposes, the products should be set in accordance with the arrows on the packaging,
- Do not store the products in a number of layers greater than 2 due to the possibility of crushing the package which in turn can lead to permanent damage of the product,

- Products placed on the means of transport must be secured against movement and damage during transport (e.g. spacers, safety belts, etc.),
- During transportation the products must be protected from the rain or snow,
- Storage places should be dry, airy and protected from the harmful effects of weather conditions (sun, rain, etc.),
- Where the weight of the product exceeds 25kg and its transportation to the place of final assembly must be carried out by at least two persons.

3.3. DESCRIPTIONS THAT HAVE TO BE PUT OBLIGATORY ON THE PRODUCT PACKAGING



Before the installation and use of the product its Technical and operation documentation, available at www.selt.com/doc-en, should be read carefully.

4. PRODUCT INSTALLATION

The following part covers general requirements of the product installation.

Proper installation is necessary for efficient operation of the product. SELT Sp. z o. o. recommends to use services of skilled installation crews what guarantees the Purchaser proper installation.

General requirements for safe installation

- it is necessary to follow general rules of construction art,
- it is necessary to follow health and safety regulations, especially concerning work with electricity and at heights,
- the product must be mounted in mechanical way (foams, glues and similar products are not allowed as fastening materials),
- the product should be mounted to permanent elements of the building (walls, lintels, steel structures, aluminum structures, window frames),
- the base where wall-ceiling brackets are mounted should be durable construction (concrete, brick, etc.),
- it is not allowed to mount the product on building structures that does not provide sufficient load-bearing capacity,
- product should be installed on even and dry wall surfaces that at the same time ensure proper strength and are completed according to general rules of building art,
- in case of constructions made of metal, in which components are welded together according to art of joining metal parts, installation is made to the structures of sufficient wall thickness,
- before starting the installation remove all unnecessary elements from the installation area,
- before starting the installation all mechanisms redundant for the drive operation should be immobilized.

4.1. REQUIREMENTS FOR SAFE INSTALLATION AT HEIGHTS



Installation of the product, because it requires performing work at heights, is particularly dangerous because it poses a high risk of danger to human health and safety and in particular fall from height.

The purchaser is obliged to conduct the installation of the product according to health and safety regulations applicable in a given country. The responsibility of the purchaser is to develop a plan for health and safety protection during installation.

Purchaser should determine specific requirements of health and safety when working at height, and especially to ensure:

- direct supervision of work execution by the designated person (e.g. the foreman),
- adequate safeguards measures, in particular protective equipment against falls from height,
- detailed instruction of employees performing work at heights,
- necessity to use ladders with appropriate quality and safety certificates, scaffoldings, safety buckles, platforms with adequate strength for anticipated load.

Work at heights that requires using personal protective equipment against falls from height, must be performed by at least 2 people.

4.2. PREPARATION TO INSTALLATION

- unpack product and check if it contains all necessary elements for installation,
- before starting the installation check the dimensions of window opening with specifications on the packaging,
- make sure that the base where product will be mounted provides sufficient bearing capacity for safe installation and operation of the product.



Attention! Pins, screws or bolts to secure the product to the structure depend on the type of substrate, and therefore are not included with the product and its purchase has to be done by the buyer or installer.

4.3. GENERAL GUIDELINES FOR INSTALLATION

- mounting of the brackets and covers should be done with appropriate bolts and pins (they are not included with the product),
- in case of reinforced concrete lintel or solid bricks, dowels should be used for mounting. Make sure their size is correctly selected for bearing capacity,
- depending of the type of the wall structure appropriate mounting system should be selected,
- longitudinal axis of the product cassette should be leveled, otherwise the product will not roll correctly
- the product should be protected against any stains made by e.g. silicon, mortar or mounting foam, which may cause its malfunction,
- using any chemical substances containing bituminous substances or any other substances making reactions with the product is forbidden.



Improper installation may cause hazardous situation for the user.

4.4. INSTALLATION TOOLS

List:

- drills for metal and concrete,
- hummer drill,
- ladder/scaffolding,
- screwdriver,
- hammer,
- tape measure,
- Pencil/pen,
- Spirit level,
- Allen wrenches,
- cutter.

4.5. INSTALLATION

Installation and operating manual and instructions for safe use is available after log in on www.selt.com.



Fabric can move on the roller tube and bottom bar during incorrect transport of the product (in vertical position). Therefore one should check fabric placement on the bottom bar and roller tube before commencing the installation.

4.5.1. GUIDE RAILS INSTALLATION

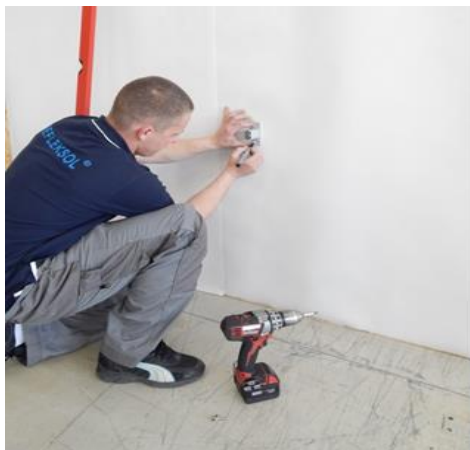

1. Designate spots in the axis of installation of brackets to the base. Put the bracket on the base and mark places for installation holes.

Img. 1



2. Drill holes, then mount the bracket using appropriate fixing system.

Img. 2

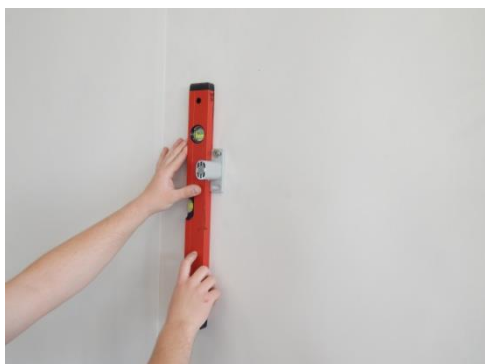

3. Check levels of the brackets, if needed correct it and secure the brackets.

Img. 3



4. Measure and mark places for installation of the remaining brackets.

Img. 4 and 5



5. Mount brackets in the designated places and check the levels

Img. 6 and 7

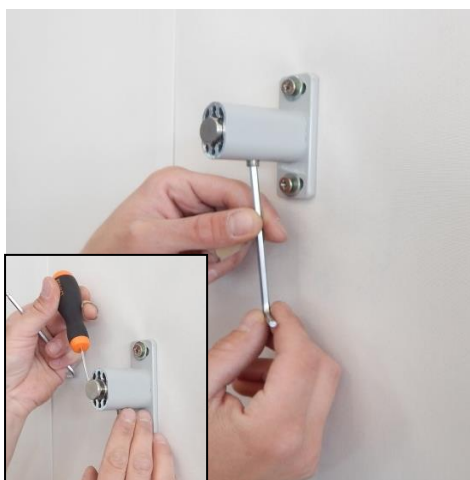

6. Loosen clamping screws, then pull out bracket bolts.

Img. 8



7. Set the guide rail in the appropriate position and push the profile onto the



Img. 9

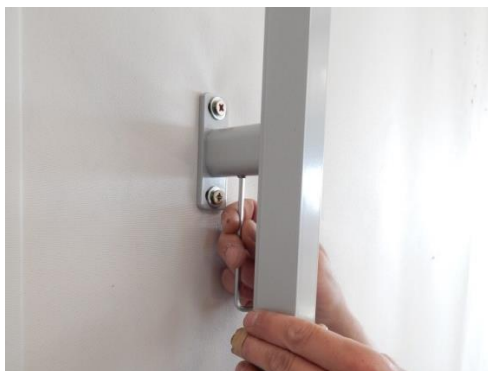

8. Set guide rail in the appropriate position and secure clamping screw in the brackets.

Img. 10



Img. 11

1. Use measure tape and spirit level to transfer installation places for second guide rail.

Next brackets should be installed in the same order as described above.

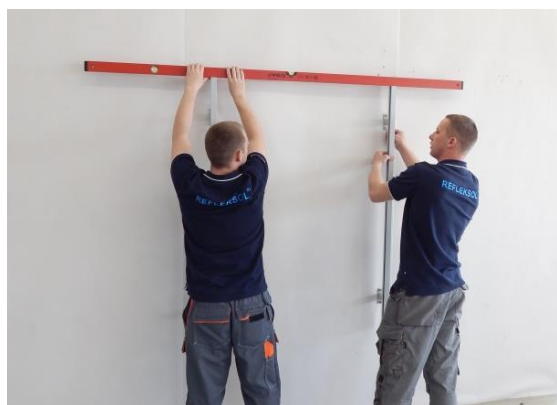

Img. 12

9. Set the level of upper edges of installed guide rails. Correct if necessary.

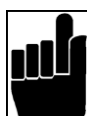

Action should be performed with accuracy, since unevenly installed guide rails can cause malfunctioning of the system.

4.5.2. CASSETTE INSTALLATION



Img. 1

1. Put cassette on the guide rails, remembering that it has to be leveled horizontally.



- Put cassette into the previously installed and levelled mounting clips. Then secure the cassette in clips with locking elements.

Img. 2



- Connect the drive to power supply and unroll the fabric.

Img. 3

4.5.3. ANTIWIND BAR INSTALLATION

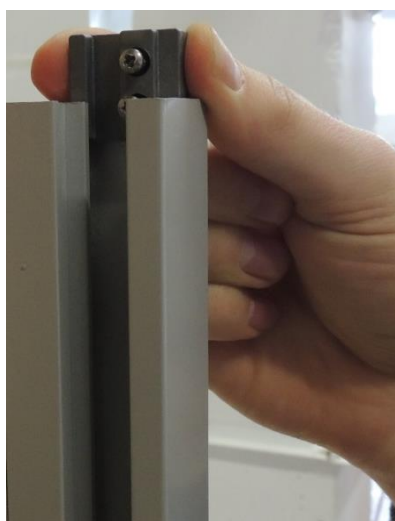

Img. 1

- Measure and mark the installation spot of antiwind bar lock and slide it to the guide.

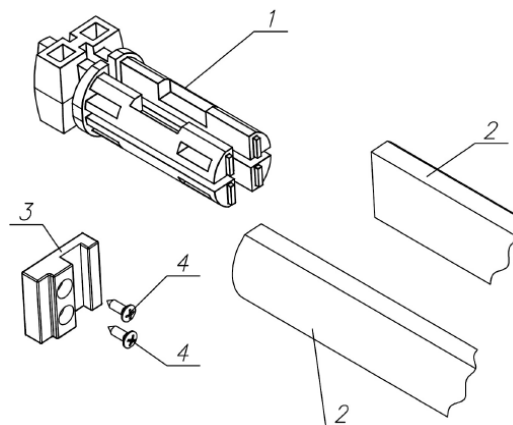

- 1 – antiwind plug
- 2 – antiwind bar
- 3 – antiwind lock
- 4 – locking screw



2. Slide the fabric in between antiwind bars, then secure the ends by sliding plugs into them.

Img. 2



3. Insert bottom bar, antiwind bars and cassette in the guide rail.

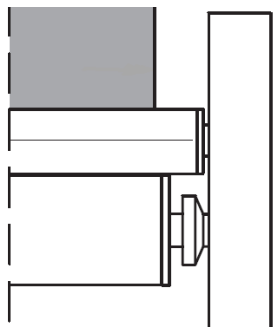

4. Manner of bottom bar and antiwind bar insertion in GC30 guide rail.

Fig. 1

4.5.4. CABLE GUIDES INSTALLTION



1. Put sleeves on the cable guides Img. 1. Place a screw in the sleeve, and best with fingers secure it until first resistance, then use flat wrench Img. 2 - and make 2 full turns. Making more turns will damage the screw head.

Img. 2

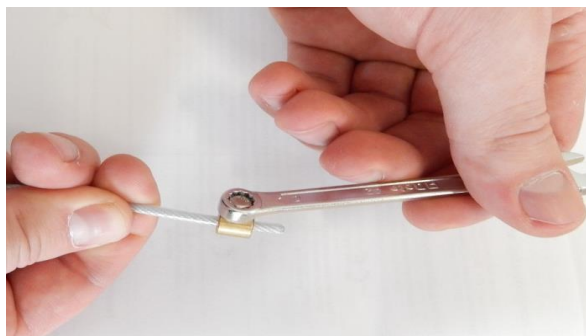

Img. 2

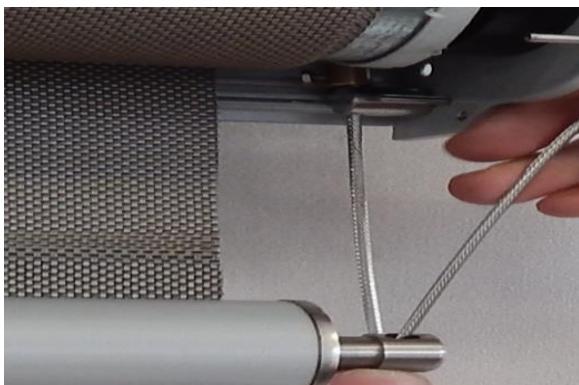

2. Take down the revision lid from the cassette. Then put the cable guide through support in the cassette and bottom bar end cap bolt.

Img. 3



3. Mark places for cable bracket installation, then install the brackets.

Img. 4



4. Mount cable guide brackets.

Img. 5



5. Put cable through façade tightener.

Img. 6



6. Install façade tightener to the bracket

Img. 7



7. Secure the cable in tightener by tightening bottom screw until first resistance then use allen key and make 1,25-1,5 turn, remembering to leave some clearance required for correct tightener functioning. Exceeding the scope given will cause breaking the head, the screw slot or key head.

Img. 8



8. Loosen upper screw (locking movable part of the tightener). Stop when the movable part pulls out.

Img. 9

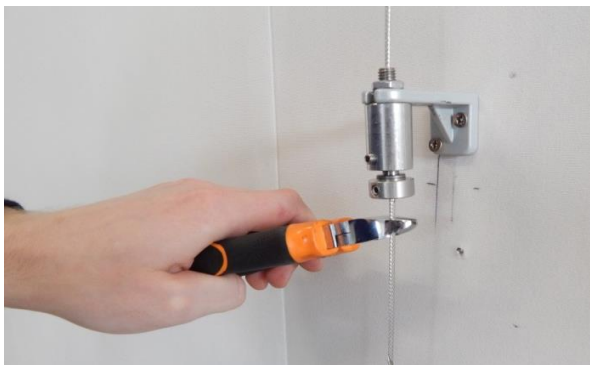

9. Cut out the excess of the cable.

Img. 10



1. Check the vertical level of the cable.
If necessary, correct by moving tightener in the bracket.

Img. 11



2. With a spirit level mark the installation place of the second cable guide bracket. Other actions make analogically to the first bracket and guide.

Img. 12

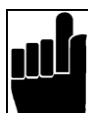

1. Check correct installation of brackets – their misplacement may cause danger for people.
2. After the installation check correct operation of the system and set end positions of the motor according to its manual.
3. Do not pull cable guides, it may end up in breaking them or damaging upper brackets.

4.6. ELECTRIC DRIVE

4.6.1. CONNECTION TO POWER SUPPLY

After the blind is installed one may proceed to connecting the drive and control system to the previously prepared systems: power supply and control systems. Connection to the power supply system should be made in accordance with the previously elaborated individual electric diagram, including fire protection regulations. The connection must be performed by an electrician holding appropriate permissions.

Electrical connection and setup of the motors must be done in accordance with the manual of motor manufacturer. Manuals are added to the product as well as are available on motor manufacturer's website and:

www.selt.com → PRODUCTS → AUTOMATION

Environmental conditions of increased threat:

bathrooms and showers, kitchens, garages, cellars, saunas, rooms for domestic animals, operating theatres in hospitals, pump rooms, heat exchange rooms, spaces limited by conducting areas, campsites, open spaces, etc. are regarded as environments with increased threat conditions.

In rooms and spaces where there are increased threat conditions, automatic devices for switching off power supply to the damaged product should be used, e.g. residual current devices. They are recommended to be used in bathrooms, kitchens, garages and cellars. Are obligatory to be used at swimming and shower pools, saunas, construction sites, while supplying appliances in open spaces, on agricultural and horticultural farms, on campsites and in camper vans, as well as in rooms where there is fire hazard.

4.6.2. START-UP AND ADJUSTMENT

- extreme position (up and down movement of the fabric) are protected by limit switches that need to be adjusted during the installation,
- adjustment of limit switches must be done in accordance with motor's maintenance manual,
- prior to the first start of the product electrical measurements should be performed,
- do not start the engine without checking the correctness of system installation.

When the product starts working attention should be paid to:

- correct rolling down and up of the fabric
- correct activation of limit switches



Incorrect connection of the motor can lead to product damage or create a hazardous situation.



The engine has a thermal switch, which turns off the drive after about 4 minutes of continuous work to protect against overheating. After turning off by the thermal protection appropriate time should pass before turning on again, depending on the type of engine and atmospheric conditions (about 16 minutes).

4.6.3. MANUAL DRIVE

- Rolling up and down of the product is performed with the use of a crank.
- Do not use excessive force when the blind reaches end position.
- Crank should be secured with crank bracket.

External ceiling installation with wall grommet

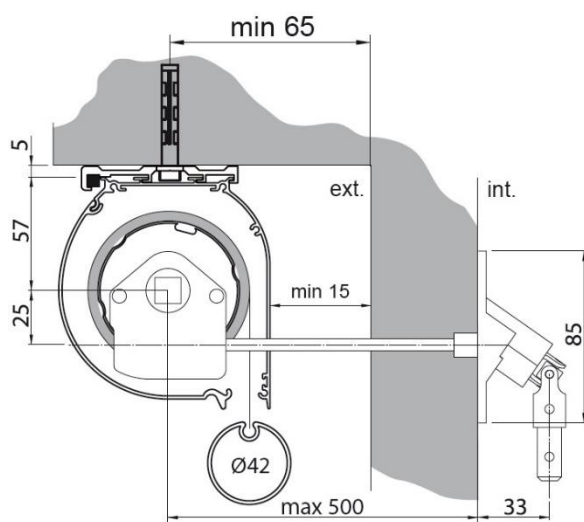

Internal ceiling installation

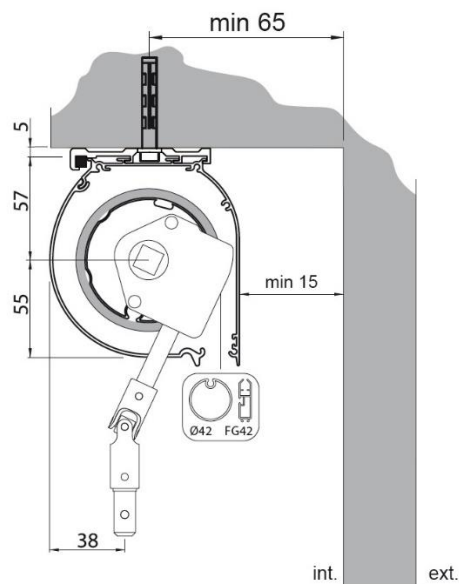

5. SYSTEM OPERATION AND PRODUCT SAFETY

5.1. GENERAL SAFETY REQUIREMENTS

- During product transport, assembly and disassembly, operation, care and maintenance, suitable regulations of industrial safety and environmental protection should be observed,
- The product should be maintained and repaired solely by the trained and suitably qualified personnel,
- The Buyer should make sure that people assigned for carrying out activities connected with current use, cleanness and maintenance of the product should be familiar with its operating manual and observe the guidelines in all points of this manual,
- Cleaning the product in a way different from the one described in the part entitled *Technical inspections, maintenance and repairs* is forbidden,
- All work must be carried out with due diligence taking into account safety requirements,
- Maintenance work and product repairs should be carried out only when the product is disconnected from the power source,
- Markings on the product should be observed (e.g. icons, arrows denoting the direction of motion),
- Make sure that markings are not covered with a layer of paint or damaged in a way making it impossible to read them,
- It is forbidden to introduce modification in the electrical design or in the equipment configuration without consulting the manufacturer or an authorised representative,
- Before the product is used, this manual should be read carefully,
- The switch should be mounted at the height conforming to the national regulations concerning disabled persons, not lower than 130cm at best.

5.2. SAFETY REQUIREMENTS CONNECTED WITH PARTICULAR CONDITIONS AND PLACES OF PRODUCT USE

Particular safety requirements refer to children at the age of up to 42 months. Particular requirements for use apply to all places accessible to little children or places where they spend time. Particular requirements for use apply also to all these places where disabled persons spend time.



Prior to beginning to use the product, the Buyer must carry out individual risk assessment of its use with particular attention paid to the safety of children and disabled persons.

While determining product operational requirements, it is essential to take into consideration rationally predictable conditions of use and potential threats.



Do not allow children to play with the control appliances of the roller blind. Keep the remote control out of the reach of children.



Control the installation frequently for signs of wear or damage to electrical cables. Do not use if repair is necessary.

5.3. OPERATION SAFETY



Product can only be used when it is defect-free.

Recommendations and actions:

- the product is safe for use as long as the recommendations included in the documentation are observed,
- disconnect the product from electrical installation before commencing any work on the building facade, not connected with the maintenance of the product,
- all work connected with inspections and repairs of the product should be carried out by a properly trained person holding adequate qualifications,
- attention should be paid to any signs of wear or damage to electrical cables,
- in case signs of wear or damage to electrical cables are found, the product must not be used, the fault should be reported to supplier immediately,
- the remote control appliances should be kept out of the reach of children,
- entering and staying in the up-down work area of the product should take place only when it is totally open and stopped,
- while folding and unfolding the product, attention should be paid that no objects or people are present within the product work area (in the space between the guides and bottom bar),
- no warm objects (e.g. irons, heaters etc.) shall be kept in proximity of the fabric.

Forbidden actions:

- Do not pull the product up by force. Doing so may result in system damage,
- Stay clear of the work area of the blind while the system is working,
- It is forbidden to use a product not conforming to the electric shock and fire safety requirements,
- It is forbidden to exceed specific work parameters of the product determined in the technical and operational documentation,
- No sharp objects or protruding elements which can hook the bottom bar can be kept near the system,
- it is forbidden to use faulty or incomplete product (e.g. without a switch), using such product may result in its damage, pose threat to user's health and life,
- It is forbidden to conduct self-repairs,
- It is forbidden to use the product and electrical installation without relevant and required inspections and measurements,
- It is forbidden to take off the electric drive casings,
- Do not touch the movable elements while folding or unfolding the blind. It may result in crushing, cutting, pulling in, or blocking between, e.g. the bottom bar and the other structural elements of the system,
- Within the work space of a blind there should be no obstacles that might interrupt its work or damage it. In case a blind enters an obstacle, first it should be folded slightly and then the obstacle should be removed,
- Stay clear of the work area of a blind while it is working.

Centrally controlled products can activate automatically. Make sure no dangerous situation arises.

SELT Sp. z o. o. shall not be responsible for damage due to improper use.



Operating the system out of one's sight can result in heavy injuries as well as system damage.

WARNING !

Do not use the product in case of strong winds, during snow falls, freezing rain. The product might be destroyed or damaged and create danger to people nearby (refers to products installed externally).

LAUNCHUNG THE PRODUCT IN TEMPERATURES BELOW ZERO MAY CAUSE ITS DAMAGE

In case any irregularities in product operation are found, the Supplier should be informed immediately. Using a damaged product and attempts to repair it on one's own pose threat to health and life and may void the warranty.

5.4. SUPERVISION OF SAFE PRODUCT USE

The Buyer should:

- a) in case safe product use depends on the conditions in which it is installed, submit the product to:
 - preliminary check (after it has been assembled and before handing it over to operation),
 - post-assembly check in another place,
- b) make sure that the product exposed to conditions causing degradation of its technical condition, which may bring about dangerous situations, is submitted to:
 - periodic checks and tests,
 - special check in case it is possible product safety should be worsened due to:
 - modification work,
 - natural phenomena,
 - prolonged downtime,
 - dangerous damage or accidents at work.

The above mentioned checks can be carried out by suitably qualified people.

6. SYSTEM USE AND MAINTENANCE

6.1. USING THE PRODUCT IN ACCORDANCE WITH ITS INTENDED USE

The system should be used in accordance with its intended use determined by the manufacturer. If the system is used and modified in a manner different from the one described within this documentation, the system is used incorrectly. Introducing arbitrary changes influencing safe operation of the product is not acceptable.

The following counts as proper product use:

- regular or predictable use which does not include, e.g. risk undertaken deliberately or consciously by the user,
- applying admissible values of work parameters,
- observing recommendations for use,
- carrying out periodic product inspections and maintenance,
- following the requirements determined in the item 'Supervision of Safe Product Use',
- data included in the item 'Technical Specifications'.

In case of improper use:

- the product can pose threat to its operators,
- the product shall be exposed to damage,
- it can be of negative influence on its functionality,
- do not use the product in the course of maintenance work (e.g. window cleaning).

6.2. INSTRUCTIONS FOR NON-PROFESSIONALS

Prior to beginning to use the product this documentation should be carefully read.

Non-professionals shall denote people who are assigned by the Buyer to carry out activities connected with routine use, cleanness and maintenance of the product.

Being familiar with this documentation guarantees fault-free operation of the product.

List of activities that can be carried out by non-professionals:

- routine operation:
 - carrying out activities which do not influence work parameters of the product,
 - switching on and off by pressing control buttons,
- product maintenance and cleanness described in the further part of this documentation.

6.3. TECHNICAL INSPECTIONS, MAINTENANCE AND REPAIRS

It is recommended to conduct periodic technical inspections of the product carried out by specialised service crews. The inspections consist in checking product operation, mechanism adjustment, and exchange of wear parts. Routine maintenance is carried out by the User themselves. Product maintenance should be performed at least once (1) a year by specialised service crews.

The inspections are provided against payment.

Basic activities carried out during a periodic inspection:

- Verification of:
 - product mounting to the structural elements,
 - technical condition of the movable elements of the product,
 - condition of electrical cables and inspection of their connection to the electrical system,
 - tension of cable guides and their correction if necessary,
 - screw and rivet connections,
 - technical condition of the fabric, guides and seals,
 - mounting of the product drive mechanism (motor, gear),
 - effectiveness of operation of the residual current device.
- Possibly adjusting and improving the mounting of the changed sub-assembly.

Products manufactured by SELT Sp. z o. o. do not require special maintenance treatment. Using the product in accordance with the manufacturer's recommendations assures the user long-term and fault-free operation. Routine maintenance activities should be carried out on a maximally opened system.

Basic product maintenance activities are:

- checking if the roller blind unfolds and folds properly,
- checking if the end switches work properly,
- cleaning visible, accessible product elements.

Cleaning metal / aluminum elements:

- It is recommended to clean slight dirt of metal / aluminum surfaces with the use of water with delicate cleaning agents.

Forbidden activities during product maintenance:

- It is not allowed to use a pressure washer, cleaning agents or solvents,
- It is forbidden to use cleaning agents with the addition of chlorine, ammonia, kerosene, acetone, and bleachers in order to clean the system, as well as in its proximity as it may cause the risk of corrosion,
- It is forbidden to use sharp tools (e.g. wire brushes), scratching cleaning agents (e.g. scouring powders, polish),
- Do not hold or pull the system or its individual elements tight,
- Do not replace individual elements! Spare parts should be original!

7. GENERAL WARRANTY CONDITIONS

General warranty conditions are available on www.selt.com. In case of no access to the SELT website, the warranty conditions can be obtained from the sales representative of SELT Sp. z o. o.

7.1. EXCLUSIONS FOR WARRANTY

Warranty does not cover:

- Damages resulting from transport other than SELT,
- Damages resulting from storage, installation or maintenance activities other than described in the technical and operational documentation or Supplier recommendations, unless those activities were conducted or advised by the Supplier,
- Damages resulting from failure to observe Supplier recommendations contained in the technical and operational documentation of the product,
- Mechanical damages,
- Damages resulting from self-modifications conducted by the user, unless it was done by the Supplier, or on behalf of the Supplier, or with its written permission,
- Secondary damages resulting from using the product regardless of the noticed faults, unless the Supplier was notified about it and recommended further use. The assessment of damage causes is left to the rational recognition of the Supplier. Repair or change of the product due to the damages described herein can be done by the Supplier against payment.
- Faults resulting from normal wear of product parts, including: seals, lubricants, etc.,
- Repairs involving regulation, cleaning and lubrication,
- Electrical devices delivered to the Supplier in a manner not allowing for operation check (e.g. cut off motor cable, receiver in parts),
- Damages resulting from incorrect installation of the product, self-repairs and adjustments,
- Damages resulting from using the product in incorrect weather conditions,
- Using the product regardless of damaged components.

Warranty for fabric does not cover:

- Horizontal pressure marks arising due to the rod slipped into the fabric pocket and fixing the fabric in the roller tube,
- Asymmetrical rolling of the fabric on the roller tube due to not centering the fabric during installation,
- Asymmetrical rolling of the fabric on the roller tube due to dirt on the fabric surface (e.g. leaves, mud etc.),
- Elastic behaviour of the fabric when working in different temperature scope (connected with thermal expansion of PVC),
- „Waving” of the fabric resulting from roller tube bending,
- „Vertical waves” on the fabric resulting from vertical tensions connected with shrinking in welding places,
- Damages caused by abnormal weather conditions, lightning strikes,
- Damages resulting from accidents and unexpected events (e.g. hurricane, tornado etc.),
- Damages resulting from improper cleaning with the use of caustic and abrasive products and with improper tools,
- Atmospheric and phytosanitary pollution,
- Effect of influence of other products or objects hanging on the fabric and not being delivered as a Selt system part,
- Differences in shade of fabrics, and in case of fabrics with metallisation – the grade of metallisation due to different production batches,
- „Memory effect of the fabric”: fabrics of bigger dimensions exceeding the width of the roll have to be done from several cloths of the fabric, turned and welded. As a result the fabric in some cases rolls up on the sides. This is due to the memory of the shape of the fabric tube. This effect can increase in high Releksol blinds and width below 120 cm. The effect subsides along with the product use,
- Gap in welding: in fabric wider than 430 cm (exceeding the width of the welding machine) it is necessary to make a cut in the pocket. The cut is hidden in the bottom bar what makes it almost invisible and does not influence the characteristics of the fabric. This is a technological norm,
- Fabric welding: when the width and height of the blind exceeds the width of fabric roll, then it is necessary to connect two fabric pieces by welding (fabrics are welded with heat and the visibility of welding is natural). Weldings repeat horizontally with frequency depending on the width of fabric roll.

8. COMPLAINTS/ TECHNICAL FAULTS

8.1. COMPLAINTS (MANUFACTURER'S WARRANTY)

Complaints can only be made by the entity that purchased the product from the manufacturer.

The terms and way of handling complaints are defined in the General Guarantee Terms and Conditions as well as the General Sales Terms and Conditions.

The General Guarantee Terms and Conditions and the General Sales Terms and Conditions are available on the website: www.selt.com.

The Customer submits a complaint on the Complaint form available on the manufacturer's B2B platform. The complaint notification should be full and complete.

A complaint submitted in a different way than via the B2B Platform, which is incomplete or partial, without given invoice number, order number or contract number, will not be considered.

8.2. TECHNICAL FAULTS

In case product defects occur, one should:

- fold the product and put it out of service,
- immediately notify the dealer about the product fault.
- notifications can be sent to the email address reklamacje@selt.com or directly to the sales representative

Complaints / faults should be made on the 'complaint notification form' which can be found on the website: www.selt.com, or directly at the customer's assistant.

9. PRODUCT DISASSEMBLY / UTILISATION / DISPOSAL



Improper system disassembly can result in severe injuries and system damage. System disassembly should be commissioned to a properly qualified assembly team or to a person suitably trained within industrial safety and with the knowledge concerning recovery.

a) Disposal of worn electrical and electronic equipment

After the end of product lifetime it must be disassembled and separate material must be segregated according to Regulation of the Minister of Environment of 9 December 2014 on waste catalogue – Dz. U. [Journal of Laws] of 2014 item 1923

Important information concerning utilisation:



Pursuant to the regulations of the Act dated of 11 September 2015 about waste electrical or electronic equipment, it is forbidden to place used appliances marked with a crossed out waste bin symbol jointly with other waste. The User wishing to dispose of electronic or electrical equipment is obliged to take it to the used equipment collection spot. The above legal obligations were introduced in order to reduce the amount of waste due to used electrical and electronic equipment and to assure a proper level of collection, recovery and recycling. There are dangerous elements in the equipment which are of particularly adverse effect on the environment and human health.

No.	Subject	European legal basis	Polish legal basis
1	Waste electrical and electronic equipment	Directive 2012/19 EU of the European Parliament and of the Council of 4 July 2012 on waste electrical and electronic equipment (WEEE)	Act of 11 September 2015 Dz. U. [Journal of Laws] of 2015, item 1688 on waste electrical and electronic equipment
2	Waste catalogue	Commission Regulation (EC) No. 574/2004 of 23 February 2004 amending Annexes I and III to Regulation (EC) No. 2150/2002 of the European Parliament and of the Council on waste statistics.	Regulation of the Minister of Environment of 9 December 2014 on waste catalogue – Dz. U. [Journal of Laws] of 2014 item 1923.

b) Disposal of waste batteries

In accordance to the Act of 24 April 2009 on batteries and accumulators final user is obliged to pass waste portable batteries, which are no longer energy source, to a collection spot or to a special collection bin. It is forbidden to put waste batteries in the same container as other waste.

In order to prevent environment pollution and posing possible threat to human and animal health, dispose of the used battery to a proper collection bin in the assigned collection spots.

No.	Subject	European Legal Basis	Polish Legal Basis
1	Waste batteries and accumulators	Directive 2006/66/EU of the European Parliament and of the Council of 6 September 2006 on waste batteries and accumulators and repealing directive 91/157/EEC	Act of 24 April 2009 on batteries and accumulators Dz. U. [Journal of Laws] of 2009 no. 79, item 666

10. MARKING AND LABELLING THE PRODUCT WITH THE CE MARK

10.1. PRODUCT COMPLIANCE WITH THE CE STANDARD

Products manufactured by SELT company meet the essential requirements of the standard introduced by the Polish Committee for Standardization as PN-EN 13561, which is confirmed by the manufacturer's declaration of performance and marking the product with the CE mark, as well as norm EN 13120 (for internal products).

In order to maintain this condition and assure safe use and maintenance of the system, the installation and operating manual and instructions for safe use must be observed.

10.2. INFORMATION ACCOMPANYING THE CE MARKING

a) Marking on the product:

SELT Sp. z o. o. Opole, ul. Wschodnia 23A
EN 13561

SELT Sp. z o. o. Opole, ul. Wschodnia 23A
2006/42/EC

b) Marking on the accompanying documents:

SELT Sp. z o. o. Opole, ul. Wschodnia 23A POLAND 13
EN 13561
REFLEKSOL 103 P.450x400 External sun protection screen wind resistance: 1 class Total solar energy transmittance g tot: 0,01-0,90* DWU 63 / R / 2017
REFLEKSOL 103 L.350x300 External sun protection screen wind resistance: 2 class Total solar energy transmittance g tot: 0,01-0,90* DWU 64 / R / 2017
REFLEKSOL 103 450x500 External sun protection screen wind resistance: 0 class Total solar energy transmittance g tot: 0,01-0,90* DWU 65 / R / 2017
*- external sun protection screen with glazing type C according to EN 14501:2005; detailed data depending on the fabric type are given in a table on manufacturer's website

SELT Sp. z o. o. Opole, ul. Wschodnia 23A POLAND 13
External roller blind (Refleksol) REFLEKSOL 103 (cable and aluminium guide version) 230V/50 Hz Power 120 to 200 W 03/DZ/2017
Internal roller blind (Refleksol) REFLEKSOL 103 (cable and aluminium guide, free-hanging version) 230V/50 Hz Power 120 to 200 W 08/DZ/2017